

MALIBU

2022 JAN TE LINTELO



DESIGN INSPIRATION

'Malibu'—designed by Jan te Lintelo—lives up to its name. This beach city, close to down-town Los Angeles, has a host of architectural highlights, which are home to numerous film stars. They are attracted by the laid-back atmosphere of sun, sea, and beaches, which gave Malibu its nickname, 'the original Surf City'. It is precisely this combination of cool, relaxed and luxurious, that we see in this sofa: a comfortable body atop an elegant frame with subtle legs, that make the sofa look like it's floating on air.



DESIGNED BY JAN TE LINTELO

Jan te Lintelo was born on 6 January, 1954, into a family of furniture retailers in Haaksbergen, in the eastern part of the Netherlands. Growing up surrounded by beautiful furniture, Jan understood the skills and craftsmanship required from artisans and designers. He went on to study furniture manufacture in Rotterdam, where he not only honed his creative skills but also learned about the business-side of the furniture trade. Practice makes perfect though, so Jan first joined the sales department of renowned, cutting-edge Dutch furniture brand Pastoe and then the equally renowned high-end Gelderland furniture factory. In 1994, he felt ready to spread his wings and started his own company, LINTELOO. He put everything he had learned—especially from customers—into designing his first collection. And he must have done something right, because decades later, Jan's first-ever design, the 'Easy Living' sofa, continues to be one of LINTELOO's best-sellers. Famous designers from all over the world have since designed for LINTELOO. But Jan himself also continues putting pencil to paper, brimming with ideas. His design characteristic remains the same throughout: the ultimate combination of generous proportions, comfort and style, executed by the best craftsmen in the business.



SPECIFICATIONS SEATING

Body: Webbed wooden frame with polyurethane foam in varying densities for optimum support and comfort, wrapped in hypoallergenic polyester fibre, 100% cotton inner cover.

Coupling system: The elements in any configuration are joined together by a velcro coupling system.

Legs: Steel.

Seat cushions: Polyurethane foam core, wrapped in a 100% cotton duvet filled with goose down and feathers or hypoallergenic polyester fibre.

Back cushions: Goose down and feathers with polyester fibre, or hypoallergenic polyester fibre only, 100% cotton inner cover.

Upholstery: Composition of fabrics depends on the customer's choice of upholstery. Leathers are either aniline or pigmented/sealed.

Seat depth: 65 cm.

Origin: Hand made in Italy.



SPECIFICATIONS TABLES AND TRAYS

Frame: Powder coated steel (bronze).

Top coffee table: Marble

Top side tables and trays: Solid walnut, protected with matt varnish.

Origin: Made in the Netherlands.

OPTIONS SEATING

Legs: Available in a bronze or gun metal finish.

Upholstery: Fabric: removable cushion covers, removable body cover, available in all fabrics from the LINTELOO collection.

Leather: removable cushion covers, fixed body cover, available in all leathers from the LINTELOO collection. Customers can opt to supply their own choice of upholstery fabric/leather. Please note: leather upholstery requires more (visible) seams than fabric upholstery. For an impression of LINTELOO's fabrics and leathers, see 'Materials' at linteloo.com

Cushions: Available with either a goose down/feather or hypoallergenic fibre filling. Please note: down/feather-filled cushions must be plumped up regularly. As seat cushions can be heavy, a combination of hypoallergenic fibre-filled seat cushions and down/feather-filled back cushions is increasingly popular.

Special features: Full set of fabric replacement covers available at 50% of the current retail price of the piece of furniture. Leather replacement covers on request.

Important: For full modular flexibility, all back cushions must be ordered separately.

OPTIONS TABLES AND TRAYS

Top: Regatti-stripe, Regatti-point or Monaco. For an impression of LINTELOO's marbles, see 'Materials' at linteloo.com

Special features: For optimum versatility of the coffee tables, legs can be easily repositioned.



MAINTENANCE

All LINTELOO furniture has been made with love and care. Of course, we want you to enjoy it, for as long as possible. Proper maintenance will prolong its lifespan, which is why each piece of LINTELOO furniture comes with a maintenance instruction booklet, also available for download at linteloo.com. Detailed information on care and cleaning, including the recommended products, can also be found at linteloo-care.nl.

Upholstery: Maintenance of the upholstery obviously depends on your choice of fabric or leather. As a rule of thumb, fabric upholstery—especially when removable—is easier to clean in case of spots and spills than leather. On the other hand, leather will handle regular wear and tear better, in a sense that the odd sign of use only adds to its character.

Cushions: Again, the level of maintenance depends on your choice of filling. Down/feather-filled cushions require regular plumping up and airing. But you may prefer the firmer seating experience and hypoallergenic qualities that a 100% polyester filling provides.

Legs: The occasional wipe-down with a damp cloth is all it takes.

WARRANTY

All LINTELOO sofas and chairs are backed by a 10-year warranty on the frame. Cushions, upholstery and all other LINTELOO products are backed by a 3-year warranty, with a depreciation of 1/3 each year. Please make sure you keep your invoice or receipt. Excluded from the warranty are:

- Regular wear and tear, damages and discolouration of upholstery (fabric and/or leather).
- Creasing, colour and structure variations and other irregularities, which are part of the natural characteristics of fabrics, leather and/or wood.
- Complaints regarding fabrics and/or leathers which are not part of the standard LINTELOO collection (specially supplied fabrics and/or leathers).
- Damages caused by improper use, inadequate or incorrect maintenance, or repairs carried out outside the scope of LINTELOO's responsibility. LINTELOO uses the Terms and Conditions of the Centrale Bond van Meubelfabrikanten, available at www.linteloo.com. If you have any questions, please contact your LINTELOO dealer or LINTELOO's customer service department.



DIMENSIONS

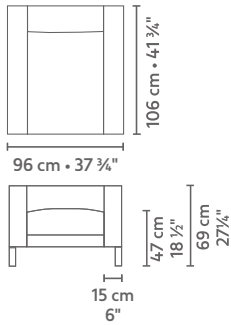

armchair 96 x 106

metrage 8,91

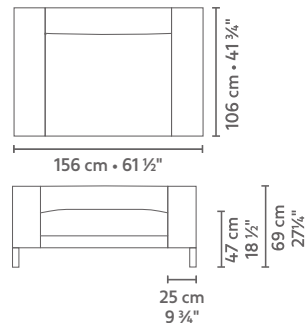

loveseat 156 x 106

9,9

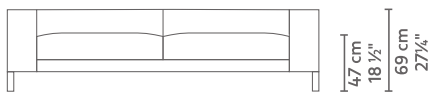
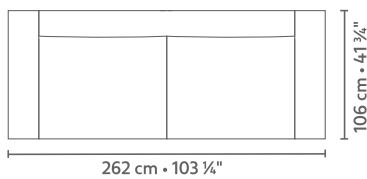

3,5 seater 262 x 106

metrage 15,11

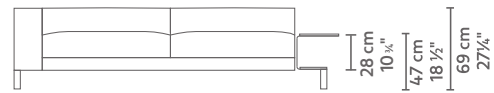
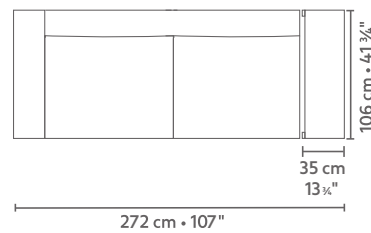

3,5 seater with arm L/R and arm table L/R 272 x 106

13,20

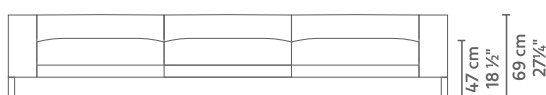
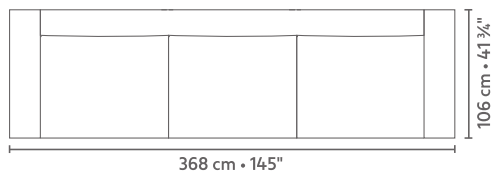

5 seater 368 x 106

metrage 20,75

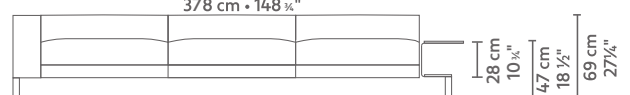
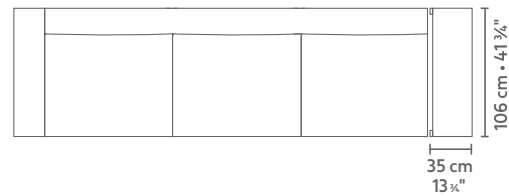

5 seater with arm L/R and arm table L/R 378 x 106

18,82

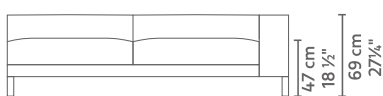
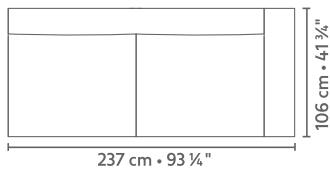

3,5 seater arm L/R 237 x 106

metrage 13,20

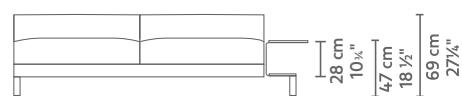
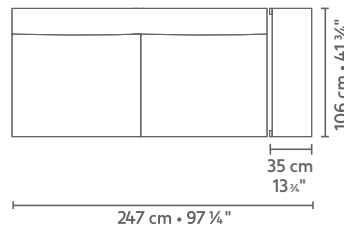

3,5 seater armtable L/R 247 x 106

11,29

DIMENSIONS

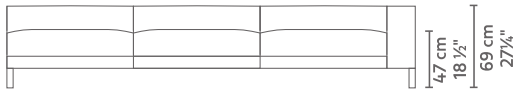
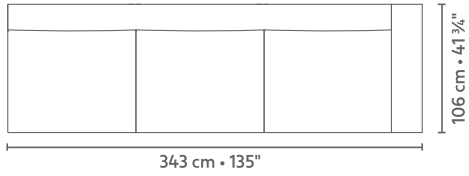

5 seater arm L/R 343 x 106

metrage

18,82

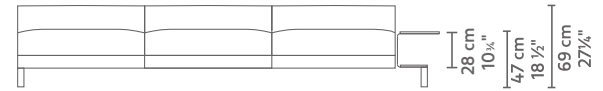
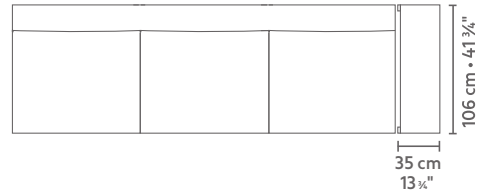

5 seater armtable L/R 353 x 106

16,89

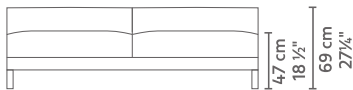
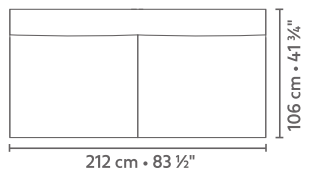

3,5 seater central element 212 x 106

metrage

11,26

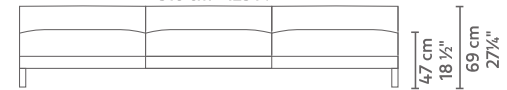
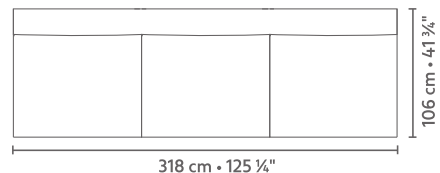

5 seater central element 318 x 106

16,90

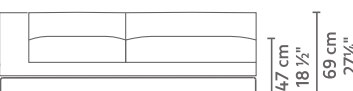
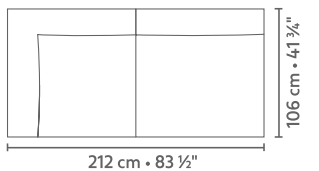

corner with central element L/R 212 x 106

metrage

12,10

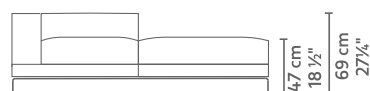
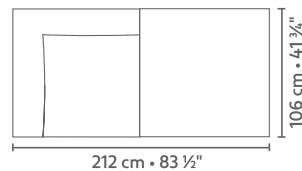

corner with terminal element 212 x 106

12,21

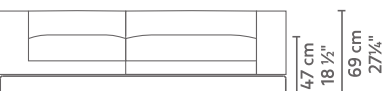
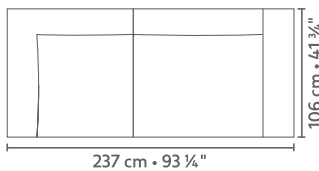

corner with element arm L/R 237 x 106

metrage

14,21

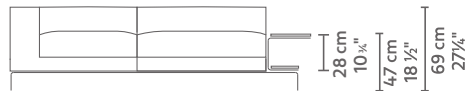
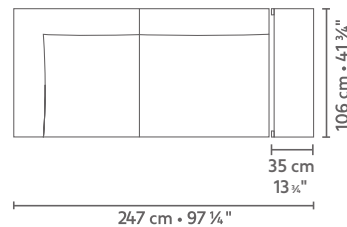

corner with element armtable L/R 247 x 106

12,30

DIMENSIONS

	<p>corner with terminal element 318 x 106</p>		<p>corner with marble element 318 x 106</p>			
metrage	17,84		15,84			
	<p>corner with element arm L/R 343 x 106</p>		<p>corner with element armtable L/R 353 x 106</p>			
metrage	19,84		17,93			
	<p>longchair arm L/R 106 x 170</p>	<p>longchair arm L/R 137 x 170</p>	<p>ottoman 106 x 106</p>			
metrage	9,00	10,12	5,56			
	<p>back cushion 55 x 55</p>	<p>back cushion 70 x 55</p>	<p>back cushion 80 x 55</p>	<p>back cushion 96 x 55</p>	<p>back cushion 106 x 55</p>	<p>back cushion 110 x 55</p>
metrage	0,90	0,95	1,20	1,38	1,60	1,60

DIMENSIONS

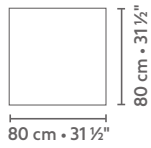

coffee table 80 x 80

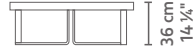
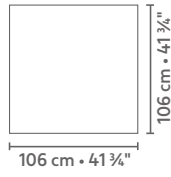

coffee table 106 x 106

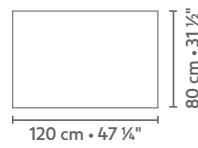

coffee table 120 x 80

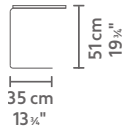
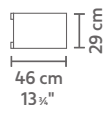

side table 46 x 29

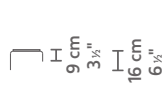
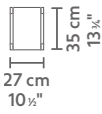

arm tray 27 x 35

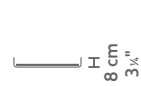
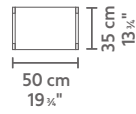

tray 50 x 35

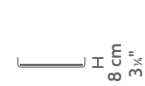
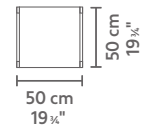

tray 50 x 50

CONFIGURATION 1

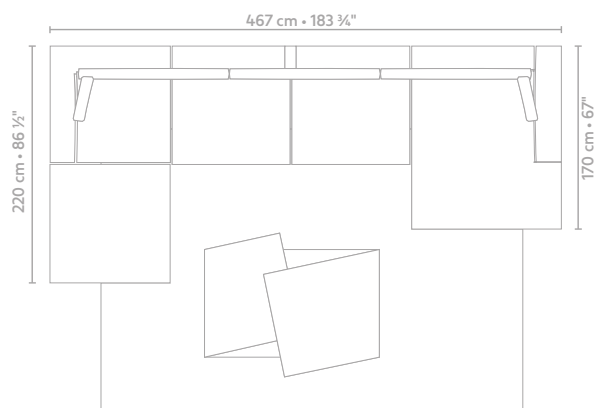

- corner with terminal element L 220 x 110
- 3,5 seater central element
- longchair arm R
- 3x back cushion 138 x 55
- 2x back cushion 48 x 48
- Tussah carpet
- San coffeetable

CONFIGURATION 2

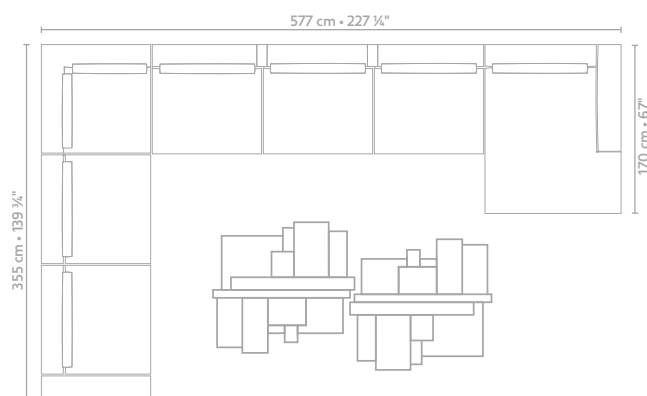

- corner with element arm L 355 x 110
- 5 seater central element
- longchair arm R
- 6x back cushion 96 x 55
- 2x back cushion 75 x 55
- 2x manhattan coffeetable

CONFIGURATION 3

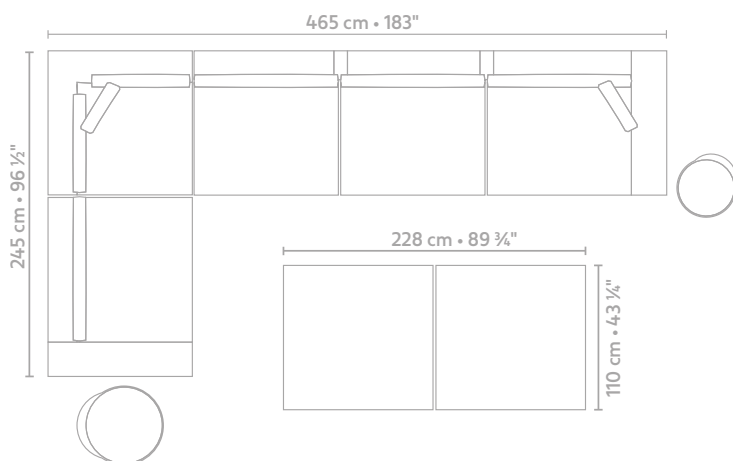

- corner with element arm L
- 5 seater arm R
- 4x back cushion 110 x 55
- 2x back cushion 75 x 55
- 2x back cushion 48 x 48
- Iwa coffee table 80 x 80
- Iwa coffee table 120 x 80